

## USER INSTRUCTIONS

### MODEL MCE-325 PROGRAMMABLE USER STATION



**PROPRIETARY NOTICE**

The product information and design disclosed herein were originated by and are the property of Bosch Security Systems, Inc. Bosch reserves all patent, proprietary design, manufacturing, reproduction, use and sales rights thereto, and to any article disclosed therein, except to the extent rights are expressly granted to others.

**COPYRIGHT NOTICE**

Copyright 2011 by Bosch Security Systems, Inc. All rights reserved. Reproduction, in whole or in part, without prior written permission from Bosch is prohibited.

\*All other trademarks are property of their respective owners.

**WARRANTY AND SERVICE INFORMATION**

For warranty and service information, refer to the appropriate web site below:

- RTS ..... [www.rtsintercoms.com/warranty](http://www.rtsintercoms.com/warranty)
- RTSTW ..... [www.rtstw.com/warranty](http://www.rtstw.com/warranty)
- AudioCom..... [www.telexaudiocom.com/warranty](http://www.telexaudiocom.com/warranty)
- RadioCom ..... [www.telexradiocom.com/warranty](http://www.telexradiocom.com/warranty)
- Headsets ..... [www.intercomheadsets.com/warranty](http://www.intercomheadsets.com/warranty)

**CUSTOMER SUPPORT**

Technical questions should be directed to:



Customer Service Department  
Bosch Security Systems, Inc.  
12000 Portland Avenue South  
Burnsville, MN 55337 USA  
Telephone: 877-863-4169  
Fax: 800-323-0498  
Info@rtsintercoms.com

**TECHNICAL QUESTIONS EMEA**

Bosch Security Systems Technical Support EMEA  
[http://www.rtsintercoms.com/contact\\_main.php](http://www.rtsintercoms.com/contact_main.php)

**DISCLAIMER**

The manufacturer of the equipment described herein makes no expressed or implied warranty with respect to anything contained in this manual and shall not be held liable for any implied warranties of fitness for a particular application or for any indirect, special, or consequential damages. The information contained herein is subject to change without prior notice and shall not be construed as an expressed or implied commitment on the part of the manufacturer.

	<b>CAUTION</b> <small>RISK OF ELECTRIC SHOCK DO NOT OPEN</small>	
THE LIGHTNING FLASH AND ARROWHEAD WITHIN THE TRIANGLE IS A WARNING SIGN ALERTING YOU OF "DANGEROUS VOLTAGE" INSIDE THE PRODUCT.	CAUTION: TO REDUCE THE RISK OF ELECTRIC SHOCK, DO NOT REMOVE COVER. NO USER-SERVICABLE PARTS INSIDE. REFER SERVICING TO QUALIFIED SERVICE PERSONNEL.	THE EXCLAMATION POINT WITHIN THE TRIANGLE IS A WARNING SIGN ALERTING YOU OF IMPORTANT INSTRUCTIONS ACCOMPANYING THE PRODUCT.
SEE MARKING ON BOTTOM/BACK OF PRODUCT.		

**WARNING:** APPARATUS SHALL NOT BE EXPOSED TO DRIPPING OR SPLASHING AND NO OBJECTS FILLED WITH LIQUIDS, SUCH AS VASES, SHALL BE PLACED ON THE APPARATUS.

**WARNING:** THE MAIN POWER PLUG MUST REMAIN READILY OPERABLE.

**CAUTION:** TO REDUCE THE RISK OF ELECTRIC SHOCK, GROUNDING OF THE CENTER PIN OF THIS PLUG MUST BE MAINTAINED.

**WARNING:** TO REDUCE THE RISK OF FIRE OR ELECTRIC SHOCK, DO NOT EXPOSE THIS APPRATUS TO RAIN OR MOISTURE.

**WARNING:** TO PREVENT INJURY, THIS APPARATUS MUST BE SECURELY ATTACHED TO THE FLOOR/WALL/RACK IN ACCORDANCE WITH THE INSTALLATION INSTRUCTIONS.

	This product is AC only.
---	--------------------------

---

## *Important Safety Instructions*

1. Read these instructions.
2. Keep these instructions.
3. Heed all warnings.
4. Follow all instructions.
5. Do not use this apparatus near water.
6. Clean only with dry cloth.
7. Do not block any ventilation openings. Install in accordance with the manufacturer's instructions.
8. Do not install near any heat sources such as radiators, heat registers, stoves, or other apparatus (including amplifiers) that produce heat.
9. Do not defeat the safety purpose of the polarized or grounding-type plug. A polarized plug has two blades with one wider than the other. A grounding type plug has two blades and a third grounding prong. The wide blade or the third prong are provided for your safety. If the provided plug does not fit into your outlet, consult an electrician for replacement of the obsolete outlet.
10. Protect the power cord from being walked on or pinched particularly at plugs, convenience receptacles, and the point where they exit from the apparatus.
11. Only use attachments/accessories specified by the manufacturer.
12. Use only with the cart, stand, tripod, bracket, or table specified by the manufacturer, or sold with the apparatus. When a cart is used, use caution when moving the cart/apparatus combination to avoid injury from tip-over.
13. Unplug this apparatus during lightning storms or when unused for long periods of time.
14. Refer all servicing to qualified service personnel. Servicing is required when the apparatus has been damaged in any way, such as power-supply cord or plug is damaged, liquid has been spilled or objects have fallen into the apparatus, the apparatus has been exposed to rain or moisture, does not operate normally, or has been dropped.



---

# Table of Contents

---

<b>DESCRIPTION &amp; SPECIFICATIONS</b> .....	<b>3</b>
Description .....	3
General .....	3
Features .....	3
Front Panel Features .....	4
Channel Selector and Operation Buttons .....	4
Volume Controls .....	4
Sidetone Nulling Trimmers .....	4
Connections, Inputs and Outputs .....	5
Front Panel .....	5
Panel Microphone Jack .....	5
Rear Panel Features .....	6
Intercom Lines .....	6
External Program Input .....	6
Speaker Output .....	6
Auxiliary Connector .....	6
Programming .....	7
Power .....	7
Mounting Configuration .....	7
MCE-325 Specifications .....	8
General .....	8
Microphone Preamplifier .....	8
Headphone Amplifier .....	8
Speaker Amplifier .....	8
Power and Mechanical .....	8
Connectors .....	8
MCS325 Specifications .....	9
<b>INSTALLATION</b> .....	<b>15</b>
Internal Programming and Adjustments .....	15
General .....	15
Intercom Line Channel Configurations (DS1-DS3, J6, J7, J19, and J20) .....	17
Front Panel Setup Mode Lock-out (DS4) .....	20
ISO (DS5) .....	20
Remote Talk-off (DS7) .....	20
VOX (DS8) .....	20
Program Assistant – IFB Option (J4, J5, J16-J18) .....	21
Balanced/Unbalanced Dynamic Microphone Selection (J24) .....	21
Headphone Sidetone Trimmer Adjustment (R37) .....	21
Speaker DIM Adjustment (R157) .....	21

Mechanical Installation .....	21
Electrical Installation .....	23
AC Power and Fuse .....	23
Intercom Lines J8, J9, J10 .....	23
General .....	23
Connector Pin Outs .....	23
4-wire Termination .....	24
Program Inputs, J14 and J15 .....	24
External Speaker, J27 .....	24
Auxiliary Connector, J22 .....	25
4-wire CH A and B Input .....	25
Key Outputs – Expanded IFB Option .....	25
Remote Microphone Switch .....	25
ISO Connection .....	26
External Headset .....	26
External Electret Microphone .....	26
External DC Power Source .....	27
Remote Speaker Mute Control .....	27
Front Panel Headset Connections .....	27
Headset Requirements .....	27
Headset Connections .....	27
<b>OPERATION .....</b>	<b>29</b>
General .....	29
Operating Instructions .....	29
Momentary/Latching Button action .....	29
LED Indicators .....	29
Channel Selection .....	29
Panel Mic/Headset Mic Selection .....	30
Microphone On/Off .....	30
Speaker On/Off .....	30
Volume Adjustment .....	30
Front Panel Sidetone Nulling Trimmer Adjustment .....	30
Sending and Receiving Call Signals .....	31
Receiving a call: .....	31
Using the Talk-Off Feature .....	31
Front Panel Programming .....	31
Activating Setup Mode .....	31
Menu Selection/Ending Setup .....	31
Submenus .....	32
Channel ID .....	32
4-channel Listen .....	32
Mono .....	32
Call Disable .....	32
Button Lock .....	33
Latch Disable .....	33
Instant Mic .....	33
Reset .....	33

# *Description & Specifications*

---

## *Description*

### **General**

The MCE-325 is a 4-channel, programmable intercom station. It may be used as a headset station or, with the addition of the MCS325 Modular Speaker, as a speaker station. It may be mounted in a console or equipment rack via optional mounting kits.

The MCE-325 can be used with either 2-wire or 4-wire intercom lines, or a combination of both. In this manual and in the labeling on the MCE-325, references to CH 1, 2, 3, and 4 indicate 2-wire lines; references to 4-wire A and 4-wire B indicate 4-wire lines.

The MCE-325 can be interfaced to a variety of external devices including external program sources, 2-way radios, paging systems, and satellite circuits. Some typical applications are shown in Figure 2 through Figure 10.

### **Features**

Call Signaling	Call signaling is accomplished using an inaudible (20kHz) signal to activate a call indicator LED.
Remote Talk-Off	Active, unattended remote station microphones may be deactivated by momentarily injecting an inaudible (24kHz) signal into the corresponding intercom line. The MCE-325 can send and receive talk-off signals.
VOX Circuit	The MCE-325 may be programmed for voice activation of the microphone.
Simple IFB	Program audio assigned to a channel is interrupted during talk.
External Device Keying	External devices, such as two-way radios, speaker mute relays, or paging systems may be activated through key outputs at the auxiliary connector on the rear panel. The key outputs may also be used to expand the simple IFB functions, allowing any number of MCE-325 stations to interrupt the program source and talk on the line.
Microphone Limiter	The microphone preamplifier circuit contains a limiter, which helps to equalize voice levels.
Fully Programmable	Retains programming even when power is shut off.

---

## Front Panel Features

### Channel Selector and Operation Buttons

These buttons have two (2) modes of operation: standard operating mode and setup mode. The printing on the face of each button indicates its function in standard operating mode; printing under each button indicates its setup mode function. (For operation and programming instructions, see “Operation” on page 29.) An LED located above each button provides status information.

The MCE-325 is factory pre-programmed for 2-channel operation, with each channel having one (1) talk and one (1) listen button. However, the MCE-325 may also be programmed so each channel selector button controls both talk and listen for a single channel, permitting operation of up to four (4) intercom channels. Additionally, users may wish to customize the identification of channels. With this in mind, a button kit has been supplied with the MCE-325 to allow you to customize the button labeling to suit your particular application. Figure 11 shows the available button caps as well as some typical button configurations.

**NOTE:** The standard buttons are opaque. As a result, the front panel LEDs may not be visible when viewing the MCE-325 from a low angle (such as when it is mounted high in an equipment rack). As a remedy for this problem, clear buttons are available to allow the LED light to pass through. For order information, contact “Customer Support” on page ii.

### Volume Controls

- CH1 (VOL 1):** This control adjusts the volume of CH 1 and/or CH 3 to the left headphone when stereo headphones are used. It adjusts the mono mix level of these channels when monaural headphones or an external speaker is used.
- CH2 (VOL 2):** This control adjusts the volume of CH 2 and/or CH 4 to the right headphone when stereo headphones are used. It adjusts the mono mix level of these channels when monaural headphones or an external speaker is used.
- PGM VOL:** This control adjusts the mono mix of program A and program B (input at the rear panel and assigned via internal programming) to the headphones and external speaker.

### Sidetone Nulling Trimmers

These trimmers are adjusted to prevent acoustic feedback when using a panel microphone along with an external speaker.



## Connections, Inputs and Outputs

### Front Panel

**DYNAMIC MIC HEADSET:** This connector accepts a stereo-earphone (5-pin connector), dynamic-mic headset (with or without a mic on/off switch), or a mono-earphone, dynamic mic headset (4-pin)

**CARBON MIC HEADSET:** This connector accepts a standard 3-conductor, 1/4-inch phone plug. The necessary phantom power is provided to power a carbon microphone or its electronic equivalent.

### Panel Microphone Jack

The MCE-325 may be optionally fitted with a gooseneck panel microphone by removing the blanking plug located in the upper-right corner of the front panel. The panel microphone jack accepts specially made gooseneck microphones (MCP-90 series), which are available from RTS.

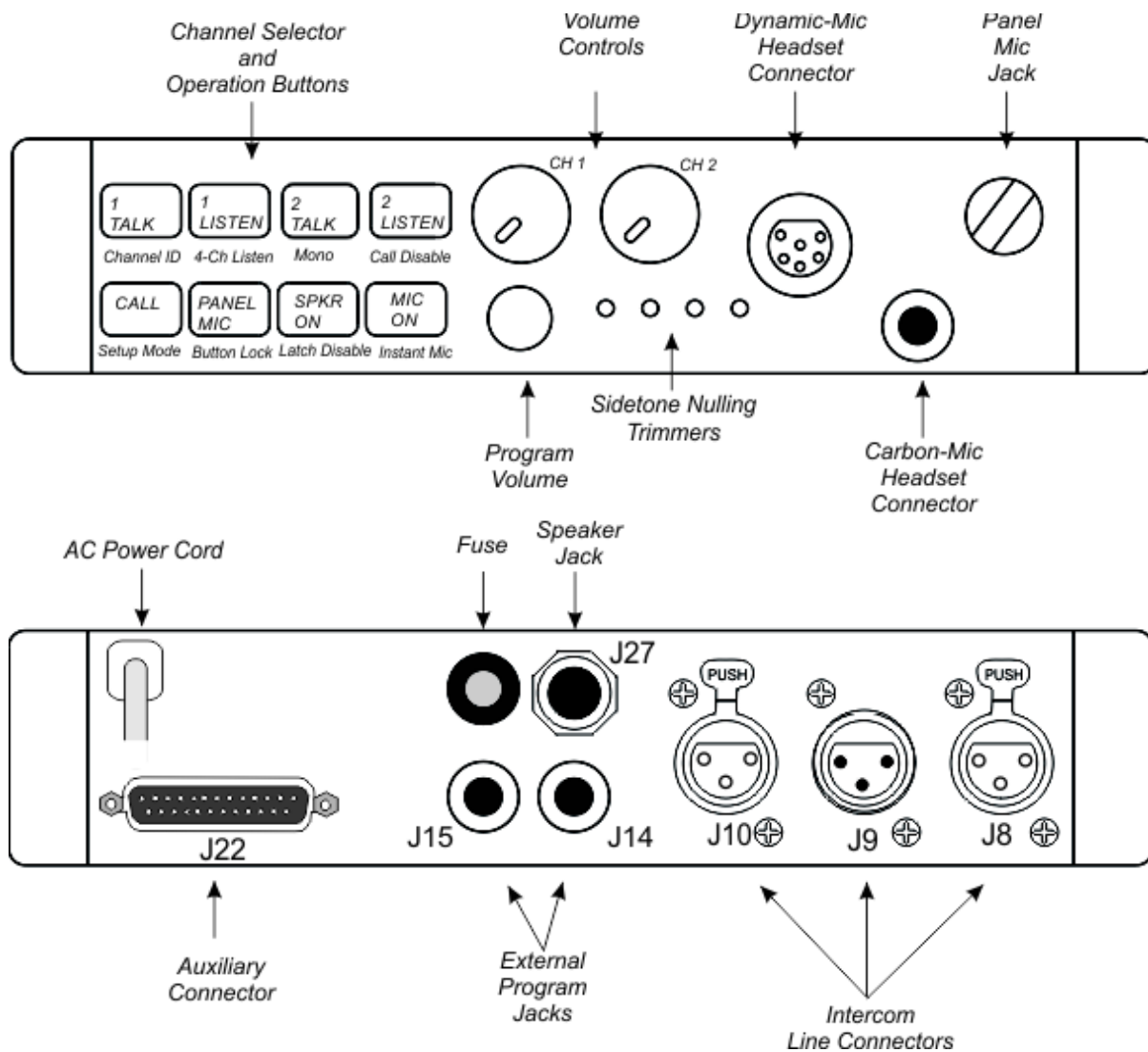

FIGURE 1. MCE-325 front and rear panel features

---

## *Rear Panel Features*

### **Intercom Lines**

Connectors J8 and J9 are parallel-wired for loop-through connection to additional stations. These connectors are used either for 2-wire CH 1 and CH 2 input/output, or 4-wire CH A output. (The 4-wire CH A input is connected at the auxiliary connector.)

Connector J10 is used for 2-wire CH 3 and CH 4 input/output, or 4-wire CH B output, but no loop-through connector is provided for these channels. (The 4-wire CH B input is connected at the auxiliary connector.)

The MCE-325 presents a bridging impedance of 10,000 $\Omega$  to the intercom line, and is designed for use with intercom lines having a 200 $\Omega$  line terminating impedance. A 200 $\Omega$  termination plug is supplied (connected to J10) to prevent channels three and four from oscillating when the MCE-325 is in 2-channel mode.

### **External Program Input**

Two (2) ¼-inch phone jacks are provided for external program input. The station accepts line-level, balanced input. The two (2) program inputs are mixed internally, and may be assigned (through internal programming) to right headphone, left headphone, external speaker, or any combination of these. In addition, program A may be assigned (through internal programming) to 2-wire CH 3 or 4-wire CH A; program B may be assigned to 2-wire CH 4, but cannot be assigned to a 4-wire channel. The program assigned to channels is interrupted during talk output.

### **Speaker Output**

A ¼-inch phone jack is provided for connection of an external speaker (8 $\Omega$  minimum impedance). The speaker output is compatible with the MCS325 speaker.

### **Auxiliary Connector**

Standard Options on the 25-pin, female, D-Sub connector are:

- Unswitched microphone output
- ISO connection to a VCP6A/VCP12A/VCP12B
- Microphone on/off switch
- Remote headset
- Remote panel microphone
- Separate inputs for +10 to +15 volts DC, and +17 to +24 volts DC
- Common/ground circuit
- 4-wire CH A and B inputs
- Remote speaker mute
- Key outputs

---

## *Programming*

Three (3) methods of programming are used:

1. Front panel programming via the channel selector and operation buttons.
2. Internal programming via circuit board DIP switches.
3. Internal programming via circuit board jumpers.

The most commonly programmed options are assigned to the front panel for convenience. Detailed information on internal programming is provided in “Installation” on page 15. Detailed information on front panel programming is provided in “Operation” on page 29.

---

## *Power*

The MCE-325 is designed for local powering, and is supplied ready for use with either 110 or 220 VAC (but not both). The unit may also be powered from an external DC source connected at the Auxiliary (J22) connector on the rear panel. For information on changing the AC supply voltage configuration, or using DC power, see “Installation” on page 15.

---

## *Mounting Configuration*

Mounting configurations are illustrated in Figure 14 on page 22 and include rack mount speaker station, console mount headset station, rack mount headset station, desk top headset station, and portable speaker station. Some mounting configurations may require a remotely located microphone or headset. These may be connected to the Auxiliary connector (J22) on the back of the unit.

## MCE-325 Specifications

### General

Bridging Impedance (to line) .....	10,000 $\Omega$ typical
Noise Contribution to 200 $\Omega$ Line.....	-90dBu
Call Signal Frequency .....	20kHz, crystal controlled
Talk-off Frequency .....	24kHz, crystal controlled

### Microphone Preamplifier

Maximum Voltage Gain .....	54dB
Frequency Response.....	100Hz to 8,000Hz, $\pm$ 3dB
Input Impedance.....	1,000 $\Omega$
Limiter Range.....	30dB

### Headphone Amplifier

Maximum Voltage Gain .....	30dB
Frequency Response.....	100Hz to 8,000Hz, $\pm$ 3dB
Headphone Impedance .....	50 to 600 $\Omega$
Output Power.....	150mW into 50 $\Omega$
Output Voltage Level.....	8Vp-p

### Speaker Amplifier

Maximum Voltage Gain .....	30dB
Frequency Response.....	100Hz to 8,000Hz, $\pm$ 3dB
Speaker Impedance .....	8 to 16 $\Omega$
Output Power per Amplifier.....	5W into 8 $\Omega$
Output Voltage Level.....	16Vp-p

### Power and Mechanical

Power Requirements .....	115 or 230VAC, 20VA max 60/50Hz 18 to 25VDC, 100 to 125mA quiescent, 900mA max
Dimensions.....	1.72" H x 8.2" W x 8" D (44mm x 208mm x 203mm)
Weight .....	4.25lbs (1.93kg)
Material/Finish .....	Thermo-plastic front panel, aluminum case, light gray finish

### Connectors

Intercom Line Connector .....	XLR type, 3-pin (male-female loop through on 2-wire CH 1 and 2, or 4-wire CH A; Female only on 2-wire CH 3 and 4, or 4-wire CH B
Dynamic Mic.....	XLR type, 6-pin female 5-pin/4-pin female XLR
Carbon Mic.....	1/4-inch phone jack, 3-circuit
Auxiliary Connector.....	25-pin, female, D-Sub
Program Inputs .....	1/4-inch phone jack, 3-circuit
Speaker Output.....	1/4-inch phone jack, 3-circuit
Panel Mic.....	1/4-inch phone jack, metal busing, 3-circuit

### MCS325 Specifications

The MCS325 is designed for use with MCE-325, but may also be used as a general-purpose monitor for program material.

Impedance .....	8Ω (DCR5.5 to 7Ω)
Power Rating .....	5W RMS continuous
Sensitivity .....	90dB ±2dB/2.83volts/one (1) meter on axis averaged over one (1) octave bands centered at 250Hz, 500Hz, 1kHz, 2kHz, 4kHz, and 8kHz when enclosed in a sealed box of 1.3 liters volume.
Frequency Response.....	200Hz to 10kHz ±4dB on 1/10 octave measurement in 1.3 liter sealed box.
Free Air Resonance .....	200Hz to 250Hz
Distortion.....	Less than 10% @ 5W at resonance.
Stray Magnetic Field .....	Less than 1 gauss at 1cm from chassis.
Mechanical Noise.....	Unit to be free of buzzes and rattles at 5W sine wave input from 100Hz to 10kHz.

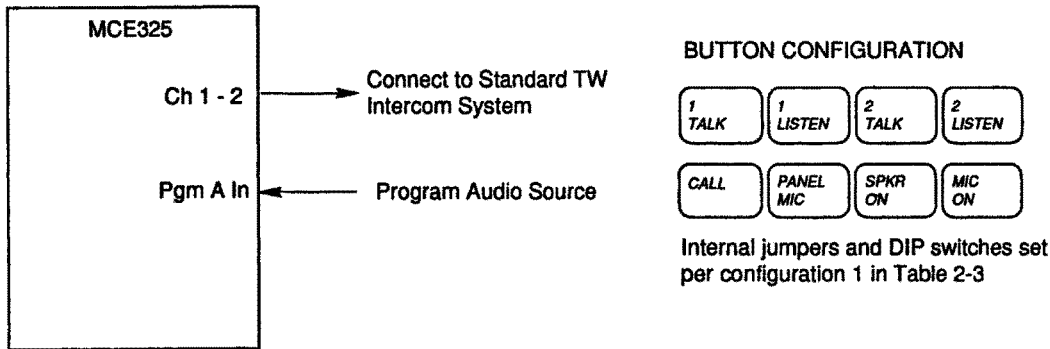

FIGURE 2. Standard 2-channel, 2-wire configuration

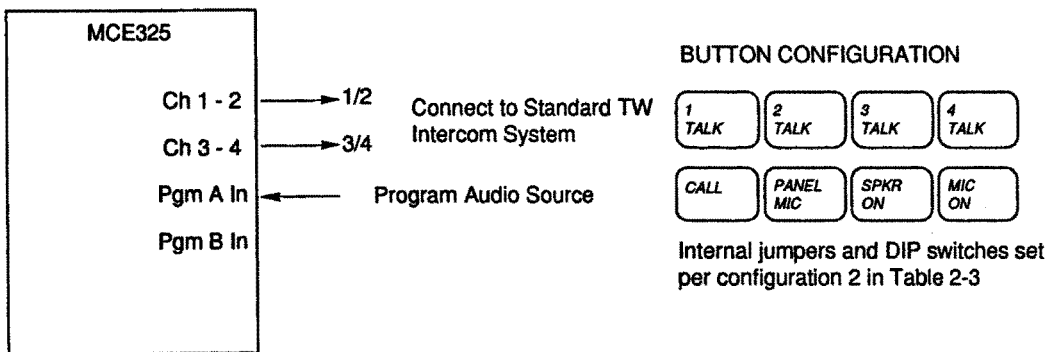

FIGURE 3. Standard 4-channel, 2-wire configuration

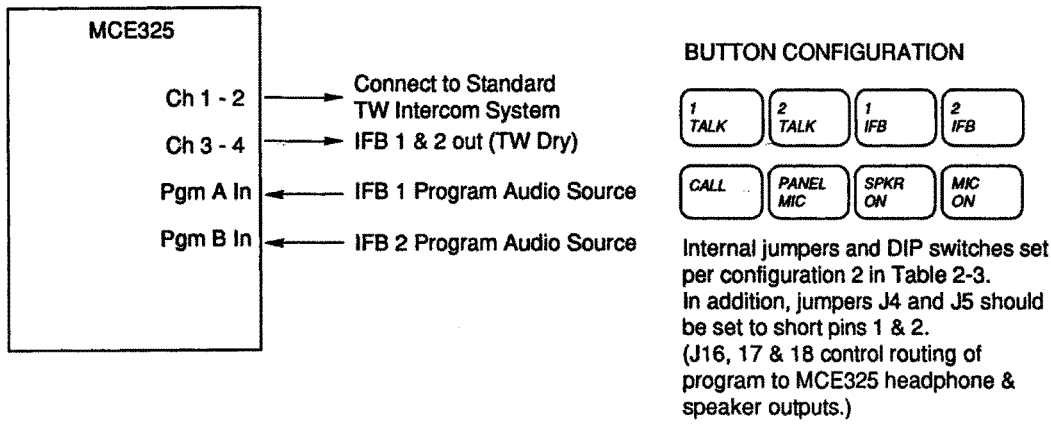

FIGURE 4. A 4-channel, 2-wire configuration with two (2) channels used for IFB's

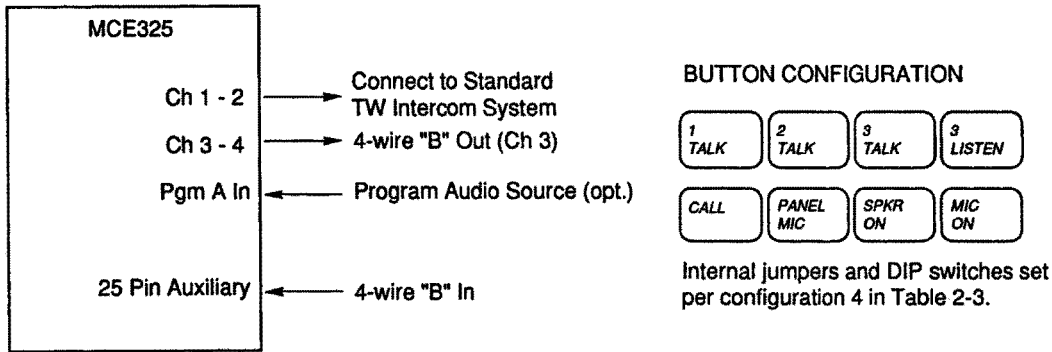

FIGURE 5. Configuration for one (1) or two (2) 2-wire channels and one (1) 4-wire channel

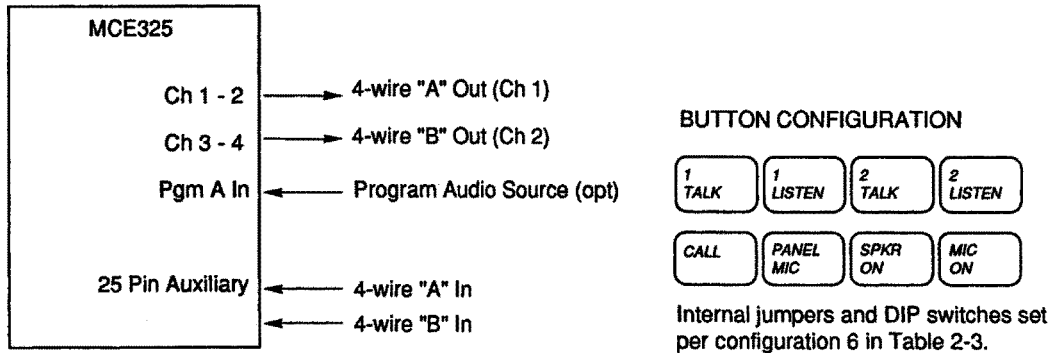

FIGURE 6. Standard 2-channel, 4-wire configuration

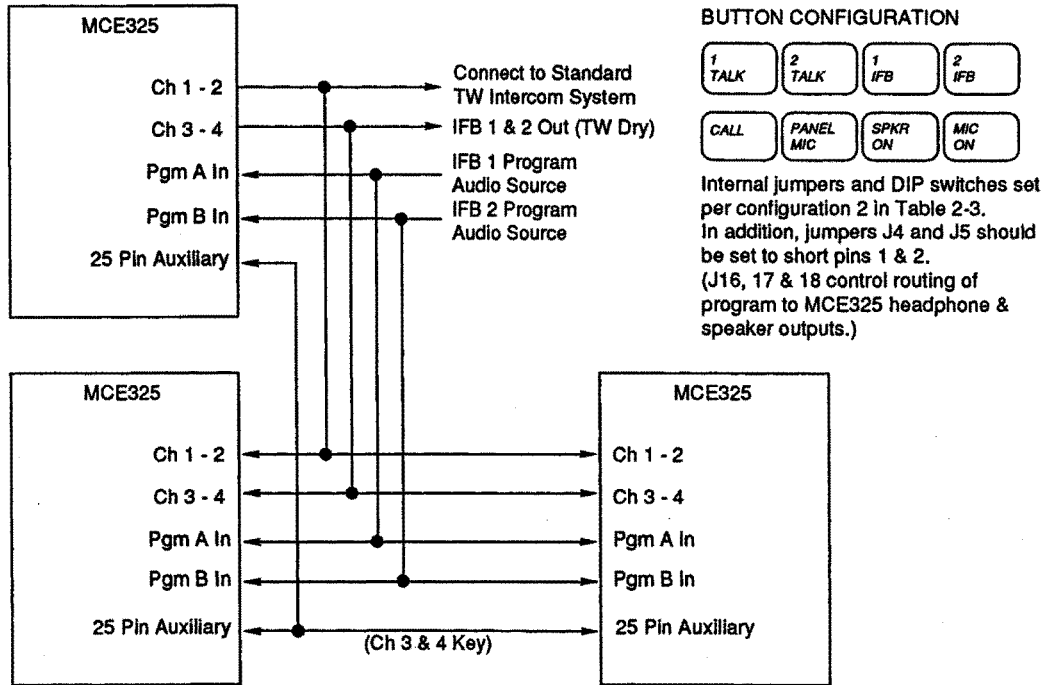

FIGURE 7. Multiple interconnected stations in 4-channel, 2-wire configuration with two (2) channels used for IFB's

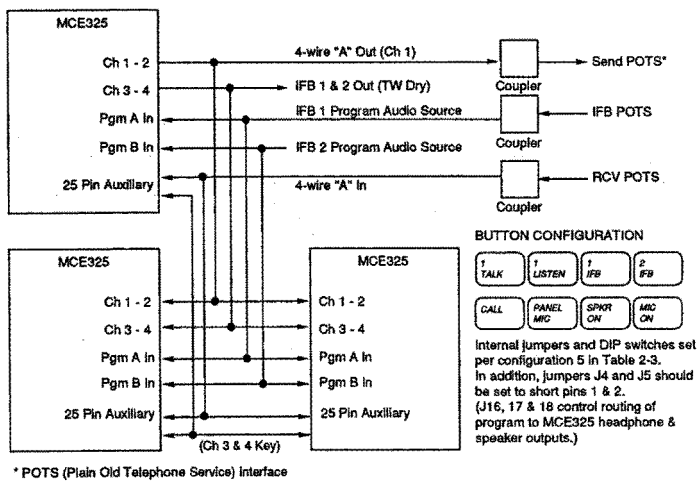

FIGURE 8. Multiple interconnected stations using one (1) 4-wire intercom channel and two (2) 2-wire channels for IFB's

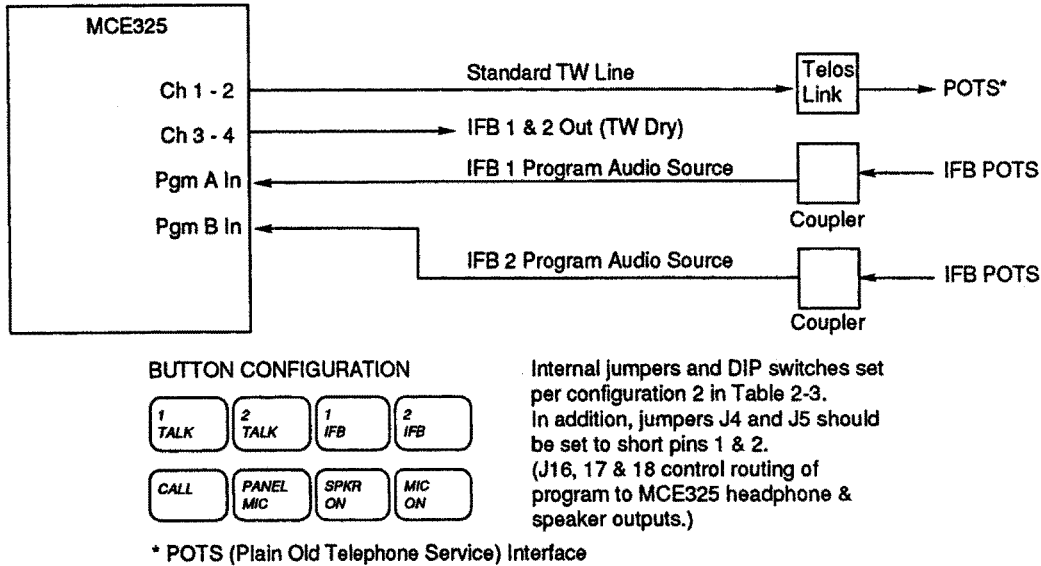

FIGURE 9. A 4-channel, 2-wire configuration with two (2) channels used for IFB's (shown with TELCO interface)

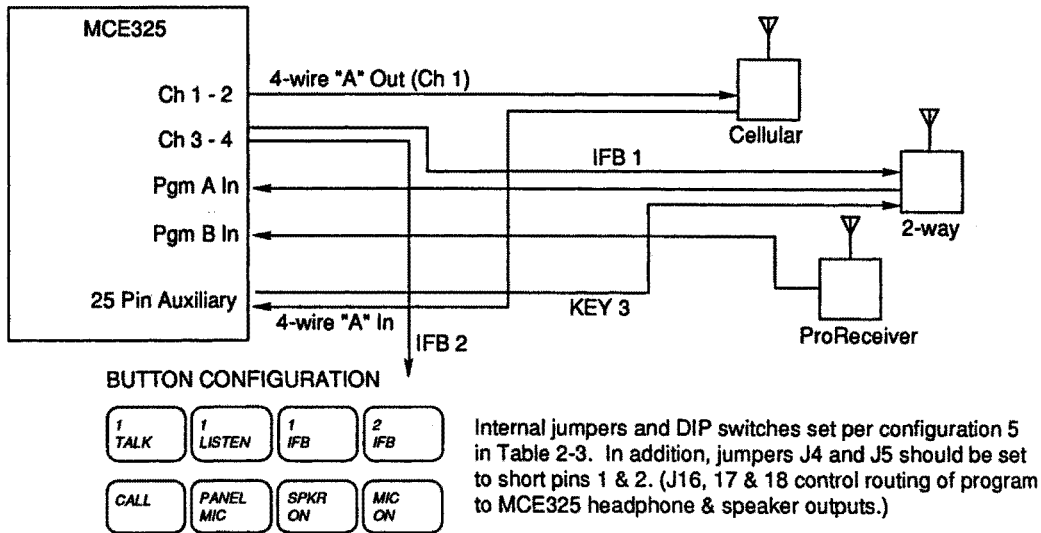
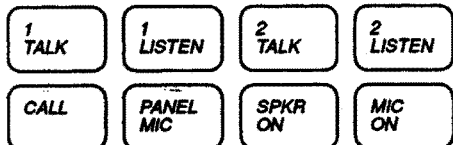

FIGURE 10. Configuration for an ENG truck using one (1) 4-wire intercom channel and two (2) 2-wire IFB's



**BUTTONS SUPPLIED WITH THE MCE325**

**Button Legends Standard on the MCE325**



**Additional Buttons for Optional Configurations**

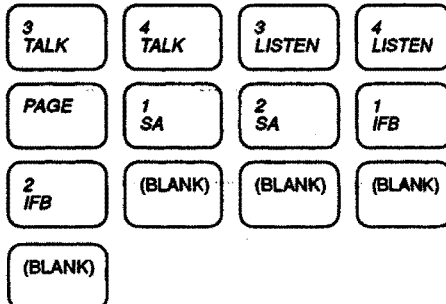

**SOME TYPICAL FRONT PANEL BUTTON CONFIGURATIONS**

**2-Channel Mode, Standard 2-Wire or 4-Wire**

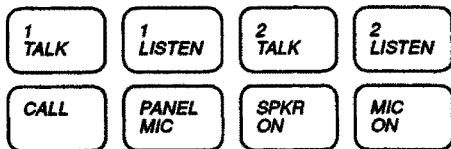

**4-Channel Mode, Alternate Version #1**

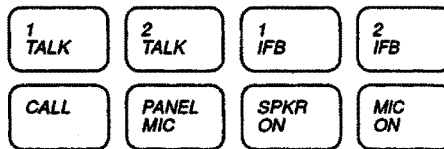

**2-Channel Mode, Alternate Version #1**

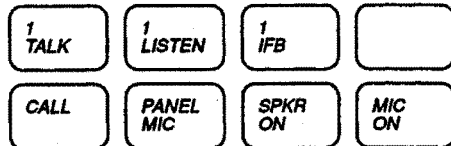

**4-Channel Mode, Alternate Version #2**

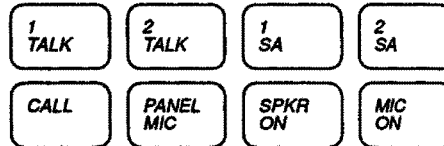

**2-Channel Mode, Alternate Version #2**

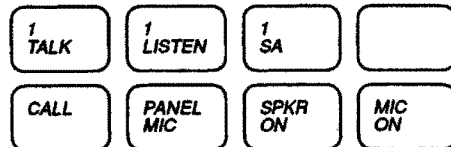

**4-Channel Mode, Alternate Version #3**

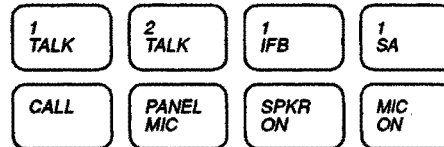

**4-Channel Mode, Standard**

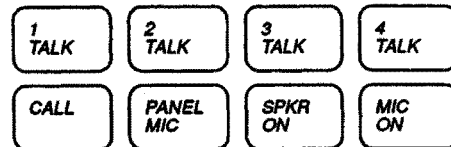

**4-Channel Mode, Alternate Version #4**

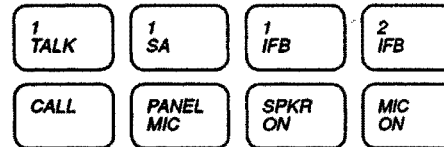

FIGURE 11. MCE-325 button configurations



---

*Internal Programming and Adjustments*

---

---

**CAUTION:** These servicing instructions are for use by qualified service personnel only. To reduce the risk of electrical shock do not perform any servicing other than what is included in the operating instructions, unless you are qualified to do so.

---

**General**

Prior to installing the MCE-325, it may be necessary to change some of the internal programming to suit your particular application. Table 1 on page 17 and Table 2 on page 18 list the functions for the DIP switches and jumpers which are used for internal programming. Also shown are the default settings were pre-programmed at the factory.

If your application requires settings different from the defaults, you have to remove the top cover of the unit (see Figure 12 on page 16) and make the required changes. If you do change the internal programming, it may be useful to note the changes for future reference.

The locations of the dip switches and jumpers are illustrated in Figure 13 on page 19. Dip switch programming is accomplished by setting switches to the off or on positions. Jumper programming is accomplished using shorting jumpers. By inserting the jumpers to short the appropriate pins, a function is either assigned or not assigned. Pin 1 of each jumper is indicated by a square symbol in Figure 13 for reference when making changes. Also, shown in Figure 13 are trimmers for adjusting the sidetone and speaker dimming levels. Usage of the DIP switches, jumpers, and level trimmers is described in the following paragraphs.

**WARNING: DISCONNECT AC POWER BEFORE OPENING UNIT.**

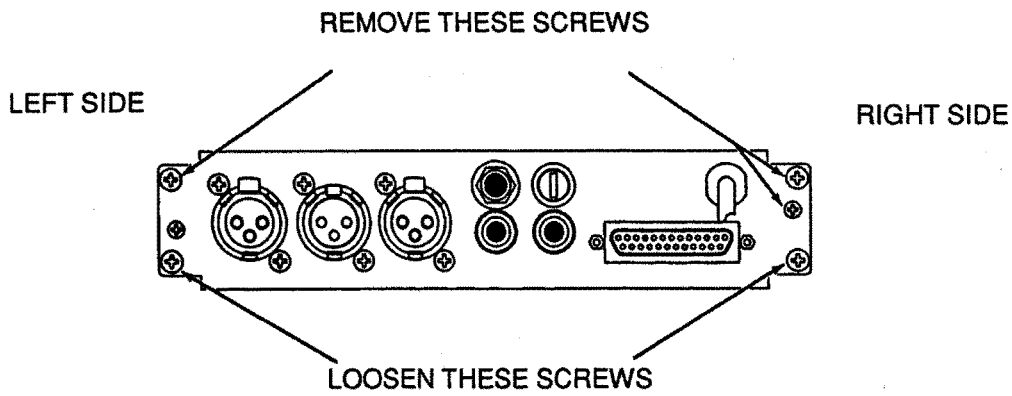

**LIFT LEFT SIDE OF TOP COVER, AND SLIDE THE RIGHT SIDE BACK FAR ENOUGH TO CLEAR TAB ON FRONT PANEL BEFORE LIFTING UP.**

**FIGURE 12.** Top cover removal

## *Intercom Line Channel Configurations (DS1-DS3, J6, J7, J19, and J20)*

The four (4) channels of the MCE-325 may be assigned to intercom lines in a variety of ways. Channel assignment is determined by the settings of DIP switches DS1 through DS3 and jumpers J6, J7, J19, and J20. There are six (6) possible intercom line configurations. These are listed in the Table 1 together with the proper DIP switch and jumper settings for each.

**TABLE 1.** DIP Switch Functions and Default Settings

<b>Switch Number</b>	<b>Switch Function</b>	<b>Default Setting</b>
DS1	4-wire CH A output not installed (Off) 4-wire CH A output installed (On)	Off
DS2	4-wire CH B output not installed (Off) 4-wire CH B output installed (On)	Off
DS3	2-channel mode (Off) <sup>a</sup> 4-channel mode (On)	Off
DS4	Front panel setup lock-out disabled (Off) Front panel setup lock-out enabled (On)	Off
DS5	Listen and talk muted during ISO (Off) Talk only muted during ISO (On)	Off
DS6	Not Used	Off
DS7	Talk-off transmit disable (Off) Talk-off Transmit enabled (On)	On
DS8	VOX disabled (Off) VOX enabled (On)	Off

- a. The terms 2-channel and 4-channel mode apply only to 2-wire lines. In 2-channel mode, each 2-wire line uses two (2) channel selector buttons: one (1) for talk and one (1) for listen. In 4-channel mode, each 2-wire line uses one (1) channel selector button for both 2-channel mode should be selected under only two (2) circumstances:
- When only 1- or 2-wire lines are connected to channels 1 and 2 only.
  - When a 2-wire line is connected to channel 1 and a 4-wire line is connected to CH B.

For all other intercom line configurations using 2-wire lines, DS3 must be set to the on position for 4-channel operation.

**TABLE 2.** Jumper Functions and Default Settings

<b>Jumper Number</b>	<b>Jumper Function</b>	<b>Default Setting</b>
J4	Assigns PROGRAM A input to 2-wire CH 3 or 4-wire CH B Not assigned: pins 2 & 3 shorted Assigned: pins 1 & 2 shorted (IFB to CH 3)	Not Assigned
J5	Assigns PROGRAM B input to 2-wire CH 4 Not assigned: pins 2 & 3 shorted Assigned: pins 1 & 2 shorted (IFB to CH 4)	Not Assigned
J6	Selects 2-wire CH1 and CH2, or 4-wire CH A output. (See J19 for CH A input) CH 1 & CH 2 selected: pins 2 & 3 shorted 4-wire CH A output selected: pins 1 & 2 shorted	2-wire operation
J7	Selects 2-wire CH3 and CH 4, or 4-wire CH B output (See J20 for CHB input) CH 3 & CH 4 selected: pins 2 & 3 shorted 4-wire CH B output selected: pins 1 & 2 shorted	2-wire operation
J16	Assigns mono mix of the PROGRAM A and B inputs to the left headphone Not Assigned: Pins 2 & 3 shorted Assigned: Pins 1 & 2 shorted.	Assigned
J17	Assigns mono mix of the PROGRAM A and B Inputs to the right headphone Not Assigned: Pins 2 & 3 shorted Assigned: Pins 1 & 2 shorted	Assigned
J18	Assigns mono mix of the PROGRAM A and B inputs to the speaker Not Assigned: Pins 2 & 3 shorted Assigned: Pins 1 & 2 shorted	Assigned
J19	Selects 4-wire CH A input. Off (not used): pins 2 & 3 shorted <sup>a</sup> On when LISTEN 1 button is on: pins 1 & 2 shorted Always On: pins 3 & 4 shorted	Off
J20	Selects 4-wire CH A input. Off (not used): pins 2 & 3 shorted <sup>a</sup> On when LISTEN 1 button is on: pins 1 & 2 shorted Always On: pins 3 & 4 shorted	Off
J21	Selects unbalanced or balanced dynamic mic input. Unbalanced: pins 2 & 3 shorted Balanced: pins 1 & 2 shorted	Unbalanced mic input

a. J19 and J20 jumpers should be in the Off position when 2-wire lines are used.

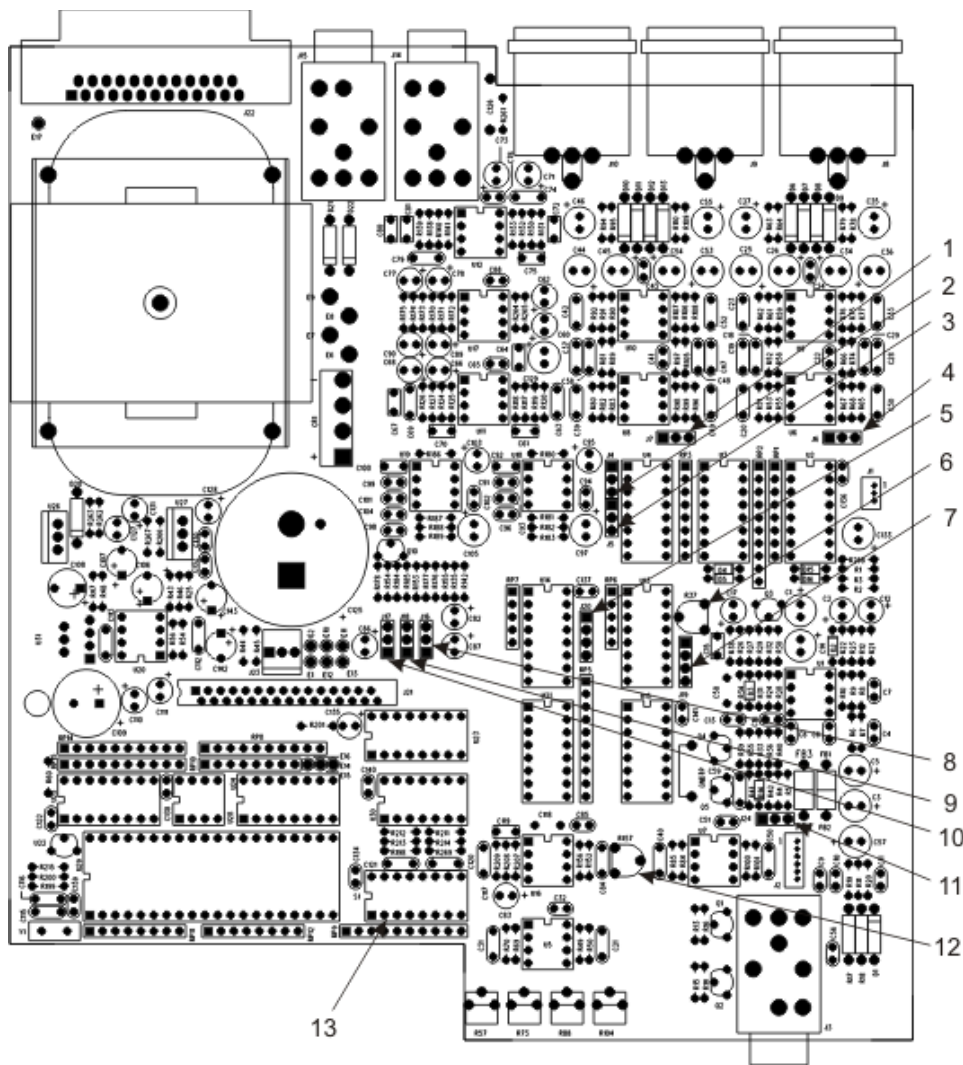

- 1. J7, Intercom Line-Channel Configurations
- 2. J4, Program Assignment - IFB Option
- 3. J5, Program Assignment - IFB Option
- 4. J6, Intercom Line-Channel Configurations
- 5. J20, Intercom Line-Channel Configurations
- 6. R37, Headphone Sidetone Trimmer Adjustment
- 7. J19, Intercom Line-Channel Configurations
- 8. J16, Program Assignment - IFB Option
- 9. J18, Program Assignment - IFB Option
- 10. J17, Program Assignment - IFB Option
- 11. J24, Balanced/Unbalanced Dynamic Microphone Selection
- 12. R157, Speaker Dim Adjustment
- 13. DS1 Through DS3, Intercom Line-Channel Configurations
- 13. DS4, Front Panel Setup Mode Lock-out
- 13. DS5, ISO
- 13. DS7, Remote Talk-Off
- 13. DS8, VOX

FIGURE 13. Internal DIP switches, jumpers, and level trimmers

**TABLE 3.** Internal programming for the various intercom line configurations

DIP SWITCHES			JUMPERS			
DS1	DS2	DS3	J6	J7	J19	J20
<b>Configuration 1:</b> Two (2) 2-wire lines (CH1 & CH2) (Default Configuration)						
Off	Off	Off	Pins 2 & 3 Shorted	Pins 2 & 3 Shorted	Pins 2 & 3 Shorted	Pins 2 & 3 Shorted
<b>Configuration 2:</b> Three (3) Or Four (4) 2-wire Lines (Ch1, Ch2, Ch3, Ch4)						
Off	Off	On	Pins 2 & 3 Shorted	Pins 2 & 3 Shorted	Pins 2 & 3 Shorted	Pins 2 & 3 Shorted
<b>Configuration 3:</b> One (1) 2-wire Line (Ch1) One (1) 4-wire Line (Ch B)						
Off	On	Off	Pins 2 & 3 Shorted	Pins 1 & 2 Shorted	Pins 2 & 3 Shorted	Pins 1 & 2 Shorted
<b>Configuration 4:</b> Two (2) 2-wire Lines (Ch1 & Ch2) One (1) 4-wire Line (Ch B)						
Off	On	On	Pins 2 & 3 Shorted	Pins 1 & 2 Shorted	Pins 2 & 3 Shorted	Pins 1 & 2 Shorted
<b>Configuration 5:</b> Two (2) 2-wire Lines (Ch3 & Ch4) One (1) 4-wire Line (Ch A)						
On	Off	On	Pins 1 & 2 Shorted	Pins 2 & 3 Shorted	Pins 1 & 2 Shorted	Pins 2 & 3 Shorted
<b>Configuration 6:</b> Two (2) 4-wire Lines (Ch A & Ch B)						
On	On	On	Pins 1 & 2 Shorted	Pins 1 & 2 Shorted	Pins 1 & 2 Shorted	Pins 1 & 2 Shorted

**NOTE:** See Figure 12 on page 33 for a summary of how the channel selector buttons work for the various configurations. The MCE-325 is typically supplied with a termination plug inserted into J10. This plug terminates CH 3 and CH 4 with 200Ω to prevent oscillations when these channels are not used. When the channels are used, this termination plug should be removed.

### Front Panel Setup Mode Lock-out (DS4)

Dip Switch DS4 may be set to lock out the front panel programming and prevent changes. Front panel programming is described in “Operation” on page 29.

### ISO (DS5)

The MCE-325 may be used with an RTS Model VCP-6A, VCP-12A, or VCP-12B Control Station to permit private conversation between the MCE-325 operator and a camera operator. When ISO mode is engaged, either talk, or talk and listen (depending on the setting of DS5) for all other channels connected to the MCE-325 is muted, and a private line is established between the MCE-325 operator and the camera operator. See “ISO Connection” on page 26 for wiring information.

### Remote Talk-off (DS7)

The MCE-325 is capable of generating and transmitting an inaudible, 24kHz signal on an intercom channel. This signal is used to turn off the microphones on any remote stations on the channel (stations with remote talk-off feature only). This feature is useful when an unattended user station with an activated microphone is introducing unnecessary noise into a line. Dip switch DS7 enables/disables this feature. When remote talk off is enabled, the talk-off signal is activated using the CALL button on the front panel. (For Operation, see “Using the Talk-Off Feature” on page 31).

### VOX (DS8)

Dip switch DS8 turns the voice activates microphone circuit on or off. Voice activation can be used with the panel microphone, a headset, or a remote microphone connected at the rear panel. (There is no adjustment for VOX sensitivity.)



### **Program Assistant – IFB Option (J4, J5, J16-J18)**

Jumper J4 assigns PROGRAM A to 2-wire CH 3 or 4-wire CH B with interrupt during talk (IFB A). Jumper J5 assigns PROGRAM B to CH 4 with interrupt during talk (IFB B). (PROGRAM B is not used in 4-wire mode.)

Jumpers J16, J17, and J18 assign the mono mix of both program inputs to the left headphone, right headphone, and speaker respectively. Program volume to the headphones and speaker is controlled by the PGM VOL control on the front panel.

See Table 2 on page 18 for jumper settings. See Figure 13 on page 19 for locations of jumpers.

### **Balanced/Unbalanced Dynamic Microphone Selection (J24)**

The MCE-325 may be used with headsets having either a balanced or unbalanced dynamic microphone. The MCE-325 is pre-programmed for use with an unbalanced microphone by shorting J24 pins 2 and 3. For balanced microphones, remove the shorting jumper and reinstall it to short pins 1 and 2.

### **Headphone Sidetone Trimmer Adjustment (R37)**

The headphone sidetone trimmer (R37) adjusts the loudness of your own voice heard in your headset when the microphone is on and the speaker is off. (It does not affect the actual level heard on the intercom lines.) This trimmer is preset so your voice level in the headphones is approximately  $\frac{3}{4}$  of the intercom line level. To prevent feedback, this signal is automatically turned off when the external speaker is turned on with the SPKR ON switch.

### **Speaker DIM Adjustment (R157)**

When an external speaker is used, switching the microphone on causes the speaker level to attenuate. The level of attenuation may be adjusted with the speaker dim trimmer (R157). The minimum attenuation of 6dB is preset at the factory (R157 fully clockwise). The range of adjustment is -6dB to -40dB.

---

## *Mechanical Installation*

Dimensional requirements for the various mounting configurations can be seen in Figure 14. Also allow an additional 4.0 inches (102mm) of rear panel clearance for connectors.

If the headset connector is remotely located (See “External Headset” on page 26), allow space between the cable and interfering sources, such as TV monitors, power supplies, and equipment with internal power supplies. The MCE-325 has no special ventilation space requirements.

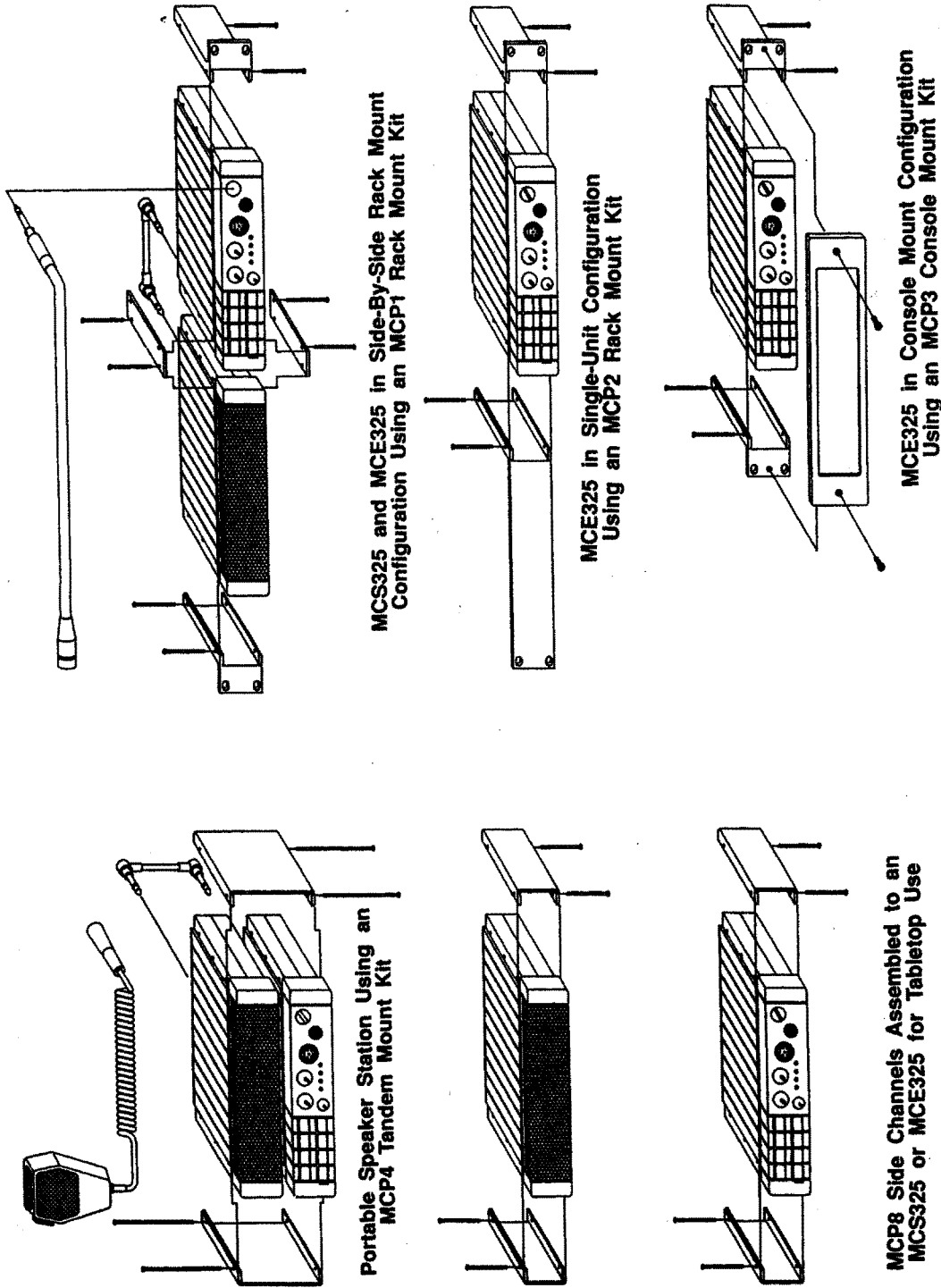

FIGURE 14. Mounting Configurations

---

## *Electrical Installation*

### **AC Power and Fuse**

The Model MCE-325 is pre-wired for either 110 or 220 VAC operation, and the appropriate fuse is already installed. The MCE-325 uses a 0.5A Slo-Blow fuse for 110 volt operation, or a 0.25A Slo-Blow fuse for 220 volt operation. A fused external DC source may be used instead of AC power if desired. (See “External DC Power Source” on page 27.)

### **Intercom Lines J8, J9, J10**

#### *General*

Intercom line connectors J8 and J9 are parallel-wired for loop-through connection to other intercom stations. These connectors are used for connection of 2-wire line to channels one and two (full-duplex operation), or for connections of 4-wire CH A output (CH A input is connected at the auxiliary connector).

Intercom line connector J10 is used for connections of 2-wire lines to channels 3 and 4 (full-duplex operation), or for connections of 4-wire CH B output (CH B input is connected at the auxiliary connector).

#### *Connector Pin Outs*

**TABLE 4.** Connectors J8 and J9

<b>Pin #</b>	<b>Function</b>
1	Common (low side of line)
2	2-wire CH 1 or 4-wire CH A high output
3	2-wire CH 2 or 4-wire CH A low output

**TABLE 5.** Connector J10

<b>Pin #</b>	<b>Function</b>
1	Common (low side of line)
2	2-wire CH 3 or 4-wire CH B high output
3	2-wire CH 4 or 4-wire CH B low output

**4-wire Termination**

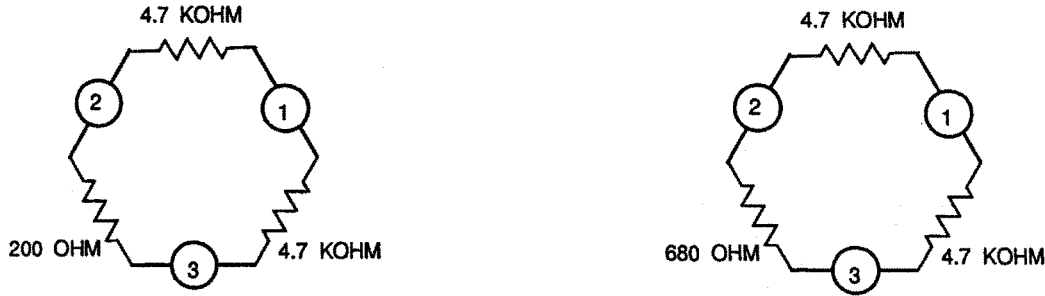

**FIGURE 15.** 4-wire Output Terminations

When 4-wire outputs are used, termination resistors must be installed for proper operation. The output amplifiers are current sources, and the output level is determined by the terminating resistor values. These resistors would normally be installed in the cable connector, but may be placed at any point in the signal path. Recommended values are shown in Figure 15.

**Program Inputs, J14 and J15**

The PROGRAM A and B inputs accept line-level (0dBu nominal), balanced audio. The program inputs are connected using ¼-inch stereo phone plugs.

**TABLE 6.** Connectors J14 and J15

Section	Function
Tip	Program High
Ring	Program Low
Sleeve	Common

**External Speaker, J27**

The SPEAKER OUTPUT jack provides a bridging-type output for an external speaker (8Ω minimum). The external speaker is connected using a ¼-inch phone plug.

**TABLE 7.** Connector J27

Section	Function
Tip	Speaker plus
Ring	Speaker minus
Sleeve	No connection

**CAUTION:** Do not let either speaker lead contact ground. The MCE-325 provides a bridging-type speaker output. The external speaker is turned on and off by the front panel SPKR ON switch.

### *Auxiliary Connector, J22*

#### **4-wire CH A and B Input**

The 4-wire CH A and CH B inputs are connected at the auxiliary connector as follows:

**TABLE 8.** Auxiliary Connector, J22

<b>Pin #</b>	<b>Function</b>
8	4-wire CH A high
21	4-wire CH A low
9	4-wire CH B high
22	4-wire CH B low

The 4-wire inputs must be assigned, using internal programming jumpers J19 and J20, before they can be used (as previously described in “Intercom Line Channel Configurations (DS1-DS3, J6, J7, J19, and J20)” on page 17.

#### **Key Outputs – Expanded IFB Option**

Four (4) logic-type outputs are available at pins 6, 7, 19, and 20 of the auxiliary connector:

**TABLE 9.** Auxiliary Connector, J22

<b>Pin #</b>	<b>Function</b>
6	CH 1 or 4-wire CH A key output
7	CH 3 or 4-wire CH B key output
19	CH 2 key output
20	CH 4 key output

There are internal pull-up resistors on the CH 3 and CH 4 key outputs. Pressing the CH 3 and CH 4 talk button results in a logic high to low transition at the corresponding key output. (Logic high is approximately 13VDC; Logic low is less than 2VDC.) There are no internal pull-up resistors on the CH 1 and CH 2 key outputs. These outputs float until externally loaded.

The CH 3 and CH 4 key outputs may also be used to expand the IFB functions, allowing any one (1) of several MCE-325 user stations to interrupt a single-point program source and talk on the interrupted channel. For example, if one (1) MCE-325 is operating with PROGRAM A assigned to CH 3, the CH 3 key output of a second MCE-325 user stations (with no program connected) can be directly connected to the CH 3 key output of the first MCE-325; activating CH 3 for talk from either station interrupts the program source and permits the station to talk on CH 3.

#### **Remote Microphone Switch**

A remote microphone switch may be connected at the auxiliary connector. Connect mic switch high to pin 24; connect mic switch low to pin 10 or 11. When the switch is closed, the microphone turns on, and the front MIC ON LED illuminates. When the remote switch is off, the microphone may be turned on from the front panel. When the remote switch is on, the microphone cannot be turned off from the front panel.

### *ISO Connection*

To connect an RTS Model VCP6A, VCP12A, or VCP12B ISO Control Panel to the MCE-325, do the following:

1. Connect the **unswitched microphone output of the MCE-325** (pins 1 and 14 of the auxiliary connector) to the **4-wire input of the VCP Control Panel**.
2. Connect the **4-wire output of the VCP Control Panel** to either a **4-wire input** or a **program input of the MCE-325**.
3. Connect the **logic contact output of the VCP Control Station** to the **ISO input of the MCE-325** (pin 12 of the auxiliary connector).
4. Connect **VCP common to pin 11** of the auxiliary connector.

### *External Headset*

An external headset may be connected to the auxiliary connector (See “Headset Requirements” on page 27).

To connect an external headset, do the following:

1. Connect **headphone left to pin 5**.
2. Connect **headphone right to pin 18**.
3. Connect **headphone common to pin 17**.
4. Connect **microphone high to pin 4**.
5. Connect **microphone low to pin 16**.

**NOTE:** The external headset connections are wired in parallel with the front panel dynamic headset connector; therefore, use only one (1) at a time.

In the headset connecting cable, prevent coupling between the microphone and headphone leads by using a shielded twisted pair for the microphone, and a separate shielded twisted pair for the headphones. Do not allow headphone common to contact microphone low. Tie the headphone shield to headphone common. The headset cable can be made longer when the microphone and headphone pairs are physically separated. The wider the separation, the longer the allowable cable length. Estimated maximum usable headphone cable lengths are as follows:

- Single cable, two shielded twisted pairs: 10ft (3.05m)
- Dual-ribbed cable, two shielded twisted pairs: 30ft (9.14m)
- Separate Shielded twisted pair cables: 50ft (15.24m)
- Balanced microphone input: up to 100ft (30.48m)

### *External Electret Microphone*

An external electret microphone may be connected at the auxiliary connector and used in place of a front panel gooseneck microphone.

To connect an external Electret microphone, do the following:

1. Connect **microphone high/bias to pin 15**.
2. Connect **microphone low to pin 2**.

**NOTE:** When using an external microphone, do not connect a front panel gooseneck microphone.

### *External DC Power Source*

The MCE-325 may be powered an external DC power supply in the 10 to 25 volt range (500mA minimum).

**NOTE:** If the external supply is in the 10 to 15 volt range, connect the positive lead to pin 13 of the auxiliary connector and connect the minus lead to pin 10 or 11. A 0.5Amp slo-blo fuse should be connected in-line for 15 to 25 volt operation.

If the external supply is in the 15 to 25 volt range, connect the positive lead to pin 23 of the auxiliary connector and connect the minus lead to pin 10 or 11.

### *Remote Speaker Mute Control*

When the MCE-325 is used with an external speaker, the speaker may be muted from a remote location. Applying a logic low signal to pin 25 of the auxiliary connector causes muting. Connect circuit common to pin 11.

## **Front Panel Headset Connections**

### *Headset Requirements*

Use headphones with an impedance of 25 $\Omega$  or greater. Low impedance 8 $\Omega$  headphones are not recommended. Headphones with good acoustic isolation (24 to 40dB) improve communication in high ambient noise environments, and allow the user to use the headphones at a less tiring, lower volume.

### *Headset Connections*

Dynamic-microphone headset connector: XLR-6 type receptacle.

**TABLE 10.** Dynamic-microphone headset connector

<b>Pin #</b>	<b>Function</b>
1	Balanced Mic Low/unbalanced Mic Common
2	Balanced/unbalanced Mic High
3	Headphone/mic Switch Common
4	Headphone Left
5	Headphone Right
6	Mic Switch High

Carbon-microphone headset connector: ¼-inch, tip-ring-sleeve phone jack.

**TABLE 11.** Carbon-microphone headset connector

<b>Section</b>	<b>Function</b>
Tip	Carbon Microphone
Ring	Headphone
Sleeve	Common/Ground





---

## *General*

The front panel buttons have different functions when the MCE-325 is switched from operating mode to setup mode. Legends on the buttons indicate their operating mode functions; legends under the buttons indicate their setup mode functions. All of the front panel buttons are pre-programmed for a certain type of operation. This is the default configuration. Operation for the default configuration is described first, and is then followed by front panel programming instructions to alter the operation.

---

## *Operating Instructions*

### **Momentary/Latching Button action**

The channel selector buttons and the MIC ON button feature a special momentary/latching dual-action: if a button is pressed and released quickly it latches (turning on if off or turning off if on); if the button is pressed and held slightly longer, the action is momentary and the button turns off when released. All other buttons are latching-only (press to activate, press to release).

**NOTE:** The latching action can be disabled through the front panel programming.

### **LED Indicators**

LED indicators are provided for each button to indicate current status. The LED can provide up to four (4) indications:

*continuously off*

*continuously on*

*short blink (50% on, 50% off)*

*long blink (90% on, 10% off).*

### **Channel Selection**

Table 12 on page 33 summarizes the operation of the channel selector buttons for the various intercom line configurations. Basically, 4-wire intercom lines always use one (1) TALK and one (1) LISTEN button for intercom communication, as do 2-wire lines when the station has been programmed for 2-channel operation.

When the station is operated in 4-channel mode, however, each 2-wire intercom line uses only one (1) channel selector button to control both talk and listen, and the MCE-325 is pre-programmed so a channel is activated for both talk and listen when the button is pressed. The button action can be changed from the front panel programming, so it controls talk only, with listen either always on or always off.

## Panel Mic/Headset Mic Selection

The PANEL MIC button selects either panel microphone (LED on) or headset microphone (LED off).

## Microphone On/Off

The MIC ON button turns the microphone on (LED on) or off (LED off).

**NOTE:** The MCE-325 can be programmed, via the front panel, so the microphone automatically turns on whenever a channel is activated for talk. The MCE-325 may also be internally programmed for voice-activated microphone (VOX) as previously described in “VOX (DS8)” on page 20.

## Speaker On/Off

The SPKR ON button turns the external speaker on (LED on) or off (LED off).

## Volume Adjustment

Table 12 on page 33 summarizes the operation of the volume controls for the various intercom line configurations. The MCE-325 is pre-programmed for stereo operation; CH 1 (VOL 1) adjusts the level to the left headphone and CH 2 (VOL 2) adjusts the level to the right.

**NOTE:**

- To use the stereo mode, you must have 5-pin stereo headset.
- The MCE-325 can be programmed, via the front panel, for monaural operation if desired.

The PGM VOL control adjusts the monaural mix of both program inputs to both headphones and to the external speaker. It does not affect the program volume on the intercom lines.

## Front Panel Sidetone Nulling Trimmer Adjustment

When the MCE-325 is used with 2-wire lines, the station operator's voice signal is not only transmitted onto the intercom lines, but also echoed back into the MCE-325 receive circuits. This can result in acoustic feedback when the MCE-325 is used with an external speaker. The sidetone nulling trimmers are used to null, or subtract, the station operator's voice signal from the rest of the received signal to prevent this feedback.

**NOTE:** This is not necessary in 4-wire systems since transmit and receive use separate circuits.

A trimmer is provided for each of the four (4) channels. The trimmers are factory-preset for maximum nulling of the microphone signal when an ideal 200Ω resistance terminates each intercom channel; however, the trimmers may require slight readjustment after the MCE-325 has been installed to compensate for variations from the ideal.

To **adjust the sidetone nulling trimmers**, do the following:

1. Turn the **speaker switch on** (even if an external speaker is not connected).  
*This turns off the internal, true sidetone trimmer (see note below).*
2. Turn **the microphone on**.
3. Activate **one (1) talk button** at a time, and speak into the microphone. Slowly increase the volume, and note the level of your voice in the headphones or speaker. Adjust the corresponding sidetone nulling trimmer to minimize your voice signal. Repeat for each channel being used, making sure only one (1) channel is activated at a time.

**NOTE:** There is also an internal, true sidetone trimmer, which allows the station operator to hear his or her voice when using headphones. This sidetone signal is turned off when the speaker switch is turned on to prevent feedback. See “Headphone Sidetone Trimmer Adjustment (R37)” on page 21 for further details.

## Sending and Receiving Call Signals

To **call a channel**, do the following:

1. Press the **CALL** button.  
*The CALL LED flashes to indicate call signal ready.*
2. Press and hold the **talk button** for the channel to be called.  
*The call signal transmits as long as the talk button is held.*
3. When a response is received, release the **talk button** to turn off the call signal.

### **Receiving a call:**

When there is an incoming call, the indicator LED above the appropriate channel selector button flashes.

## Using the Talk-Off Feature

The Talk-Off feature deactivates the mic switches of all remote user stations on a selected channel.

To **use talk-off**, do the following:

1. Press and release the **CALL button three (3) times** in rapid succession.  
*The CALL LED turns on to indicate talk-off signal ready.*
2. Momentarily press the **talk button** for the channel to be deactivated.  
*This causes the talk-off signal to be transmitted.*
3. Release the **talk button** to end the talk-off signal transmission.

---

## Front Panel Programming

### Activating Setup Mode

To **activate setup mode**, do the following:

- > Press and hold the **CALL** button for 5 seconds.  
*The TALK 1, LISTEN 1, TALK 2, LISTEN 2, PANEL MIC, SPKR ON, and MIC ON LEDs begin to flash. This is the main menu.*

### Menu Selection/Ending Setup

The submenu names are listed under the switches.

1. Press the **desired switch** to access the submenu.
2. Press the **CALL button** from a submenu to return to the main menu.
3. Press the **CALL button again** to exit from the main menu to the operating mode.

**NOTE:** If no submenu is selected from the main menu within 12 seconds after program mode activation, the programming mode times out, and the MCE-325 returns to normal operation. If a submenu is selected, however, the unit remains in programming mode until intentionally exited.

## Submenus

The following paragraphs describe each of the submenus. The default, or factory pre-programmed setting, is also indicated for each submenu.

### *Channel ID*

The MCE-325 can be programmed so when someone is talking on an intercom channel, the corresponding listen button LED flickers as they talk to provide a visual indication of which channel is talking. The button's LED indicates the selected mode as follows:

*Short LED blink:* Channel ID disabled. (default).

*Long LED blink:* Channel ID enabled.

### *4-channel Listen*

When the MCE-325 is operating in 4-channel mode, each channel selector button may be individually programmed for one (1) of three (3) types of operation. With the 4-channel Listen submenu activated, press each channel selector button one (1) or more times to select the desired type of operation as follows:

*Short LED blink (50% on, 50% off)* - Button must be pressed to talk or listen (default).

*Long LED blink (90% on, 10% off)* - Listen is always on; button must be pressed to talk.

*LED off:* Listen is always off; button must be pressed to talk.

### *Mono*

The headphone output may be configured for either monaural or stereo operation. With the Mono submenu selected, press the Mono button one (1) or more times to select the type of headphone output as follows:

*Short LED blink (50% on, 50% off)* - Stereo (default).

*Long LED blink (90% on, 10% off)* - Monaural.

### **NOTE:**

- To use the stereo mode, you must use 5-pin stereo headsets.
- To use mono mode only, you must use 4-pin mono headsets.

### *Call Disable*

Call disable prohibits incoming or outgoing call indication and signaling on selected channels. With the Call Disable submenu selected, press each talk button to select the desired operation as follows:

*Short LED blink (50% on, 50% off)* - Call function enabled (default).

*Long LED blink (90% on, 10% off)* - Call function disabled.

**Button Lock**

Button lock permits all buttons (except CALL) to be individually programmed for one (1) of three (3) types of operation. With the Button Lock submenu selected, press each button one (1) or more times to select the desired type of operation as follows:

*Short LED blink (50% on, 50% off)* - No button lock (default).

*Long LED blink (90% on, 10% off)* - Button locked in the on position.

*LED off* - Button locked in the off position.

**Latch Disable**

Latch disable may be used to prohibit latching action for individual channel selector buttons and the MIC ON button. With the Latch Disable submenu selected, press each channel selector button or the MIC ON button one or more times to select the desired type of operation as follows:

*Short LED blink (50% on, 50% off)* - Latching enabled (default).

*Long LED blink (90% on, 10% off)* - Latching disabled.

**Instant Mic**

Talk buttons may be individually programmed to automatically activate the microphone when pressed. With the Instant Mic submenu selected, press each talk button one (1) or more times to select the desired type of operation as follows:

*Short LED blink (50% on, 50% off)* - Instant mic off (default).

*Long LED blink (90% on, 10% off)* - Instant mic on.

**Reset**

To **restore the original programming**, do the following:

- > Hold down the **CH 1 talk button** for about two (2) seconds while powering up the MCE-325.

**TABLE 12.** Front panel control usage for the various intercom line configurations

VOLUME CONTROL USAGE		CHANNEL SELECTOR BUTTON USAGE			
CH 1 (VOL 1)	CH 2 (VOL 2)	1 TALK	1 LISTEN	2 TALK	2 LISTEN
Configuration 1: Two (2) 2-wire lines (CH 1 & CH 2). (Default configuration.)					
CH 1	CH 2	CH 1 TALK	CH1 LISTEN	CH 2 TALK	CH 2 LISTEN
Configuration 2: Three (3) or four (4) 2-wire lines (CH 1, CH 2, CH 3, CH 4)					
CH 1 & CH 3	CH 2 & CH4	CH 1 TALK & LISTEN	CH 2 TALK & LISTEN	CH 3 TALK & LISTEN	CH 4 TALK & LISTEN
Configuration 3: One (1) 2-wire line (CH 1); One (1) 4-wire line (CH B).					
CH 1	CH B	CH 1 TALK	CH 1 LISTEN	CH B TALK	CH B LISTEN
Configuration 4: Two (2) 2-wire lines (CH 1 & CH 2); One (1) 4-wire line (CH B).					
CH 1	CH 2 & CH B	CH 1 TALK & LISTEN	CH 2 TALK & LISTEN	CH B TALK	CH B LISTEN
Configuration 5: Two (2) 2-wire lines (CH 3 & CH 4); One (1) 4-wire line (CH A).					
CH A & CH 3	CH 4	CH A TALK	CH A LISTEN	CH 3 TALK & LISTEN	CH 4 TALK & LISTEN
Configuration 6: Two (2) 4-wire lines (CH A & CH B).					
CH A	CH B	CH A TALK	CH A LISTEN	CH B TALK	CH B LISTEN

---

**Bosch Security Systems, Inc.**

12000 Portland Avenue South  
Burnsville, MN 55337 U.S.A.  
[www.boschcommunications.com](http://www.boschcommunications.com)